

# Technical File

## Kasual Line - Desk Fix

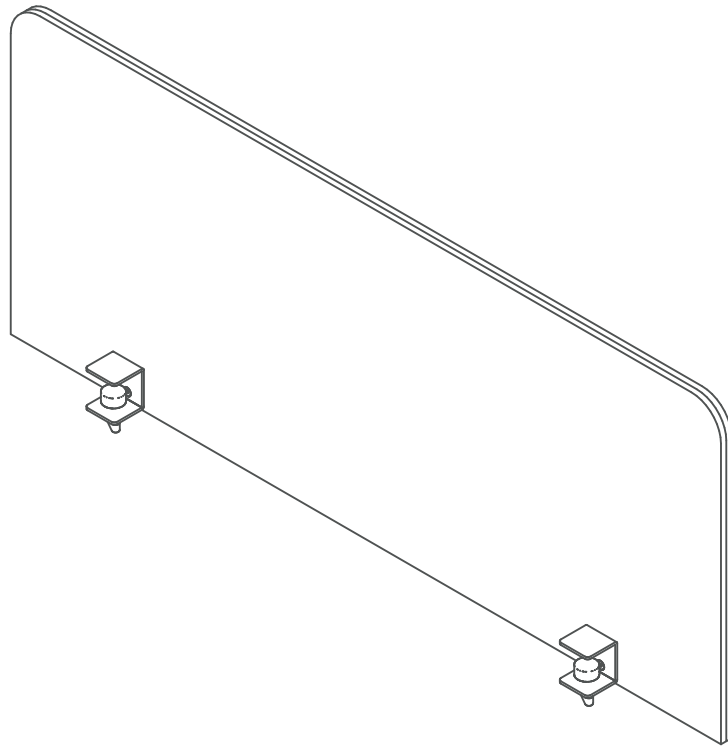

# 01

## Dimensions

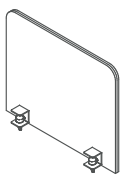
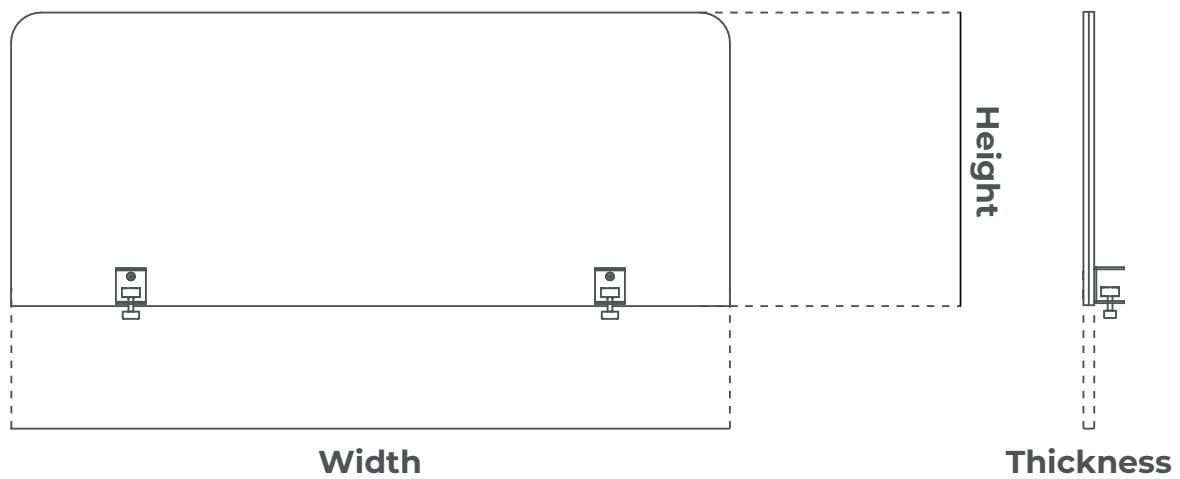

### Desk Fix

#### LATERAL

Width: 600mm Height: 490mm Thickness: 20mm

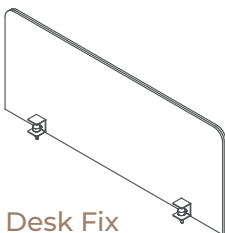

### Desk Fix

#### FRONTAL

Width: 1200mm Height: 490mm Thickness: 20mm  
Width: 1400mm Height: 490mm Thickness: 20mm

# 02

## Finishes



**Composition** 100% Polyester  
**Weight** 200 gr/m<sup>2</sup>  
**Thickness** 1,75 mm  
**Colour Fastness to light** EN ISSO 105-B02: 6-7  
**Flame Retardancy** EN 13501-1: B-s1,d0  
**Abrasion resistance** 50 000 Cycles  
**STANDARD 100 by OEKO-TEX®**

**Felt | Solid Colour**  
Pearl

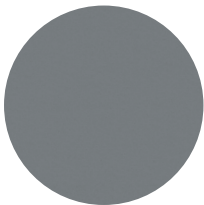

**Composition** 100% Polyester  
**Weight** 200 gr/m<sup>2</sup>  
**Thickness** 1,75 mm  
**Colour Fastness to light** EN ISSO 105-B02: 6-7  
**Flame Retardancy** EN 13501-1: B-s1,d0  
**Abrasion resistance** 50 000 Cycles  
**STANDARD 100 by OEKO-TEX®**

**Felt | Solid Colour**  
Storm

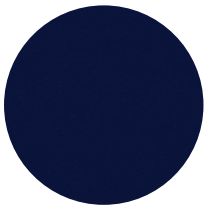

**Composition** 100% Polyester  
**Weight** 200 gr/m<sup>2</sup>  
**Thickness** 1,75 mm  
**Colour Fastness to light** EN ISSO 105-B02: 6-7  
**Flame Retardancy** EN 13501-1: B-s1,d0  
**Abrasion resistance** 50 000 Cycles  
**STANDARD 100 by OEKO-TEX®**

**Felt | Solid Colour**  
Indigo Blue

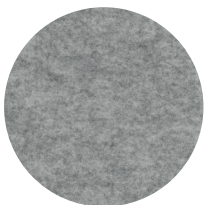

**Composition** 100% Polyester  
**Weight** 200 gr/m<sup>2</sup>  
**Thickness** 1,75 mm  
**Colour Fastness to light** EN ISSO 105-B02: 6-7  
**Flame Retardancy** EN 13501-1: B-s1,d0  
**Abrasion resistance** 50 000 Cycles  
**STANDARD 100 by OEKO-TEX®**

**Felt | Melange Finish**  
Pewter

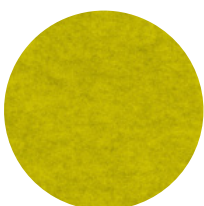

**Composition** 100% Polyester  
**Weight** 200 gr/m<sup>2</sup>  
**Thickness** 1,75 mm  
**Colour Fastness to light** EN ISSO 105-B02: 6-7  
**Flame Retardancy** EN 13501-1: B-s1,d0  
**Abrasion resistance** 50 000 Cycles  
**STANDARD 100 by OEKO-TEX®**

**Felt | Melange Finish**  
Lemon

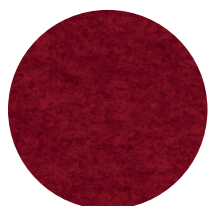

**Composition** 100% Polyester  
**Weight** 200 gr/m<sup>2</sup>  
**Thickness** 1,75 mm  
**Colour Fastness to light** EN ISO 105-B02: 6-7  
**Flame Retardancy** EN 13501-1: B-s1,d0  
**Abrasion resistance** 50 000 Cycles  
**STANDARD 100 by OEKO-TEX®**

**Felt | Melange Finish**  
Ruby

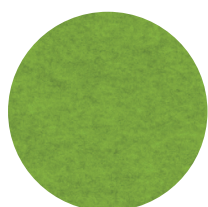

**Composition** 100% Polyester  
**Weight** 200 gr/m<sup>2</sup>  
**Thickness** 1,75 mm  
**Colour Fastness to light** EN ISO 105-B02: 6-7  
**Flame Retardancy** EN 13501-1: B-s1,d0  
**Abrasion resistance** 50 000 Cycles  
**STANDARD 100 by OEKO-TEX®**

**Felt | Melange Finish**  
Kelly

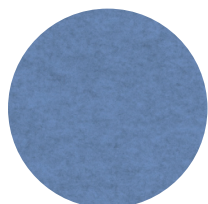

**Composition** 100% Polyester  
**Weight** 200 gr/m<sup>2</sup>  
**Thickness** 1,75 mm  
**Colour Fastness to light** EN ISO 105-B02: 6-7  
**Flame Retardancy** EN 13501-1: B-s1,d0  
**Abrasion resistance** 50 000 Cycles  
**STANDARD 100 by OEKO-TEX®**

**Felt | Melange Finish**  
Cerulean

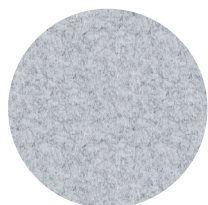

**Composition** 100% PET  
**Thickness** 9 mm  
**STANDARD 100 by OEKO-TEX®**

**PET Finish**  
Light Grey